

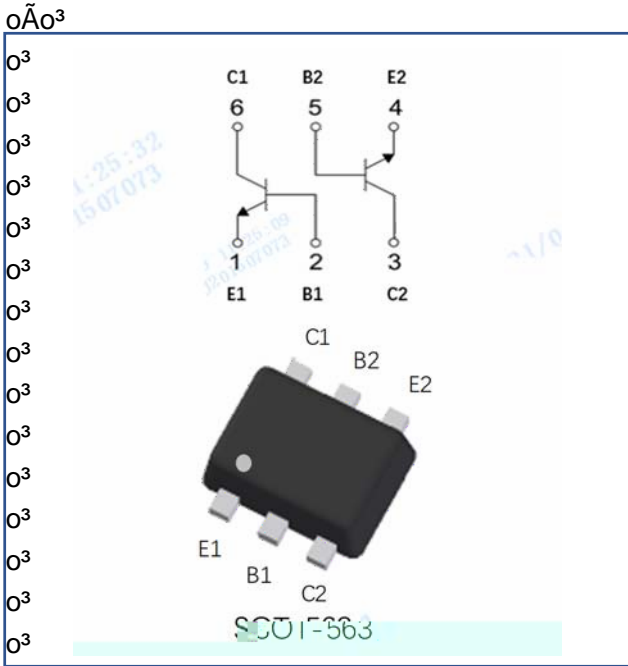

00'7 9

RoHS
COMPLIANT

'XDO 131 6PDOO 6LJQDO 7UDQVLVW



)HDWXUHV

z 0RLVWXUH VHQVLWLYLW\ OHYHO
 z +DORJHQ IUHH DQG 5R+6 FRPSOL
 z 6XUIDFH PRXQW SDFNDJH LGHDO
 PDWLF ,QVHUWLRQ

\$SSOLFDFWLRQ

z 6LJQDO DPSOLILFDWLRQ
 z 6ZLWFKLQJ FLUFXLW

OHFLOHF À 'O Q€'€

0³

,WHP	6\PERO	8QLW	&RQGLWLRQV	9DOXH
'HYLFH PDUNLQJ FRGH				.\$3
&ROOHFWRU EDVH YROWDJH	&%2		9 X\$(, 9	,
&ROOHFWRU HPLWWHU YROWDJH	(%2		& P\$ % 9	,
(PLWWHU EDVH YROWDJH	(%2		9 (X\$&, 9	,
&ROOHFWRU FXUUHQW	&	P\$,	
3RZHU GLVVLSDWLRQ	3	P:		
-XQFWLRQ WHPSHUDWXUH	-	-	7	WR
6WRUDJH WHPSHUDWXUH	67'	-	7	WR

0³

0³

0³

0³

0³

0³

0³

6⁰³6
5HY

0DU

<DQJ]KRX <DQJMEH HOKQWQRQL&ZZ/WGDQJMLH FRP



00'7 9 0"

RoHS COMPLIANT

0³
0³
0³
0³

,WHP	6\PERO	8QLV	&RQGLWLRQV	0LQ	7\S	0D[
&ROOHFWRU EDVH EUHDNGRZQ	YROWD	JH X\$ (, 9				
&ROOHFWRU HPLWWHU EUHDNGRZQ	YROWD	JH X\$ (, 9				
(PLWWHU EDVH EUHDNGRZQ	YROWD	JH X\$ (, 9				
%DVH FXWRII FXUUHQW			9&(9 (2)) 9 \$			
&ROOHFWRU HPLWWHU FXWRII	FXUUHQW	9 (2)) ,9\$		9		
	K(&(9 &, P\$ 9			

' & FXUUHQW JDLQ



00'7 9

RoHS
COMPLIANT

v7KHUPDO &KDUDFWHULVWLFV

3DUDPHWHU	6\PERO	8QLW	9DOXH
7KHUPDO UHVLVWDQFH MXQFWLRQ WR DPELHQW		- :	
7KHUPDO UHVLVWDQFH MXQFWLRQ WR FDVH		- :	

1RWH
o o 7KHUPDO UHVLVWDQWR DPELHQW & P P
FRSSHU SDG DUHDV

v&KDUDFWHULVWLFV

)LJ#6 WDWLF & KDUDFWHULVWLFV o#' & XUHQW *DLQ

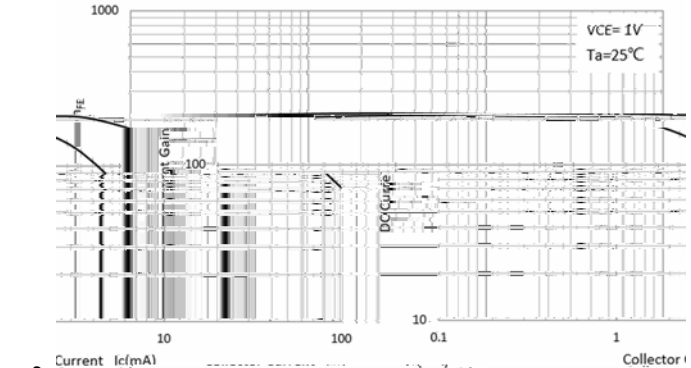
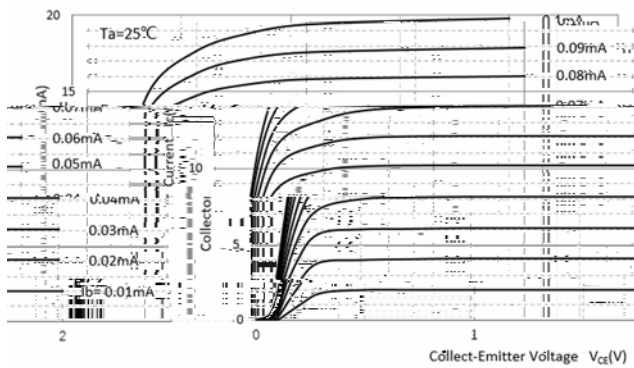

)LJ# & ROOHFWRU (PLWWHU 6DWXU D#%DRQ (@IRVOWHDJ6HDW&UDWLRQ

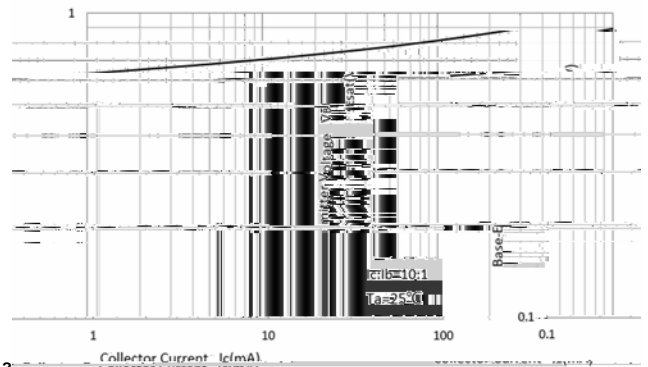



00'7 9

RoHS
COMPLIANT

)LJo# % DVH (PLW WHU 9 ROW DJH o#&RE & L&E 990³

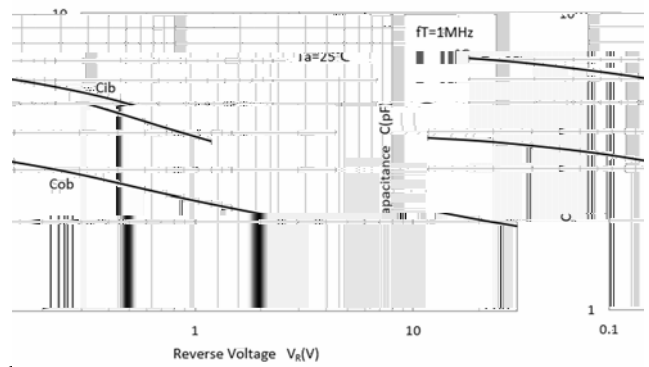

0³ 0³ (

0³

)LJo#3 7D & X0BYH

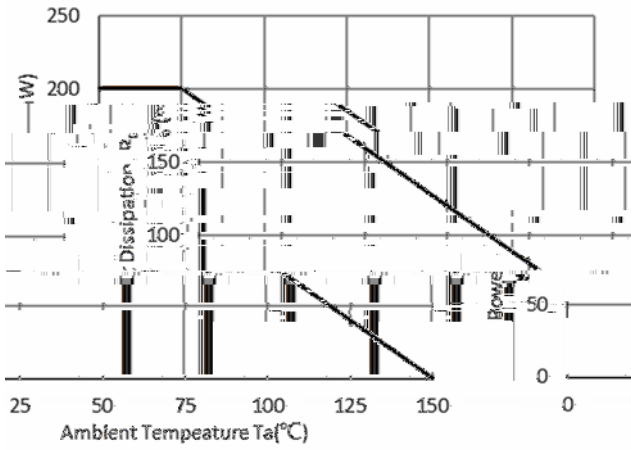

0³

0³
0³
0³
0³
0³
0³
0³
0³
0

3

0

3



00'7 9 0"

RoHS COMPLIANT

0³

v2UGHULQJ ,QIRUPDWLRQ

0³

3UHIHUUH	3DFNL FRGH	8QLW ZHLJ	0LQLPXP SDFNDJH	,QQHU ER TXDQWLW\	2XWHU FDU TXDQWLW\	'HOLYHU\ PRGH
00'7 9)	\$SSUR[LPDWH				

UHHO

v2XWOLQH 'LPHQVLRQV

0³

SOT-563

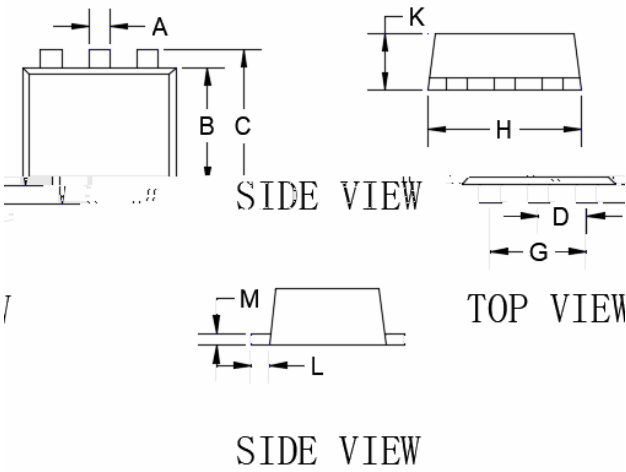

DIM	DIMENSIONS			
	INCHES		MM	
	MIN	MAX	MIN	MAX
A	0.006	0.011	0.150	0.300
B	0.043	0.051	1.100	1.300
C	0.059	0.067	1.500	1.700
D	0.016	0.024	0.400	0.600
G	0.035	0.043	0.900	1.100
H	0.067	0.080	1.700	2.000
K	0.011	0.020	0.300	0.500
L	0.020	0.030	0.500	0.750
M	0.007	0.010	0.200	0.300
	0.004	0.007	0.100	0.180

0³

v6XJJHVWHG 3DG /D\RXW

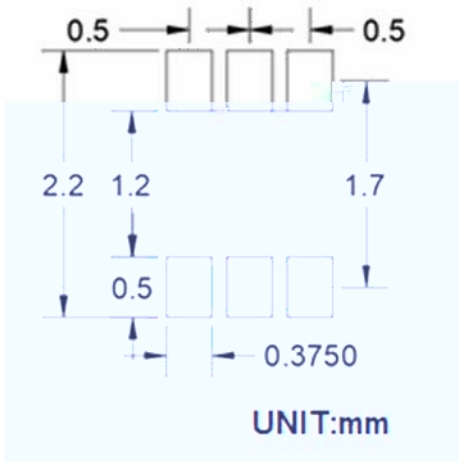

0³

0³

0

3

0

3



00'7 9 0"

RoHS
COMPLIANT

0³

'LVFODLPHU

7KH LQIRUPDWLRQ SURGXFWV LQ IRWLVH QJH RFXH RQ OMLH (OHFWURQLF 7HFKQRORJ
ULJKW WR PDNH FKDLQH VRZLWKR XWSKFLSDURGXERQ RGLWSOD\HG KHUHLQ WR GPSURQ
RU RWKHUZLVH

7KH SURGXFW OLVWHG KHUHLQ LV GHOLJHQ GRWR FEHTXV SEHZLW R UR LGHLYQ FHWW DQG
HTXLSPHQW RU GHYLFHV ZKLFK UHTXLW KHKE DIO IXQFHWL RQ URH QILWEL Q RWO DGE KUDFW O
PHGLFDO LQVWUXDWLRQ HTXDQV S W W DHUUR Q S E DHI PL DFKLDQ WRU FRQWURO CHWY IX
GHYLFHV <DQJMLH RU DQIRQH RQ LWV O E W K DQJ OD VEX D H W Q I R W H V S R Q D R E J X W H U H V
RI VDOH

7KLV SXEOLFDFWLRQ SVXSSHUW DQGLV LQURUPDWXLSRQ LSGHYR UR XDG L R W L R S O D H D V R W L P L W R X
KWWS://[www.dqjmlh.com](#) QVXOW \RX Q V D O H V R I D Q J M L H W D Q F W K H U D

0³