





# YJP240G10H

**Electrical Characteristics** ( $T_J=25$  unless otherwise noted)

	Symbol	Conditions	Min	Typ	Max	
--	--------	------------	-----	-----	-----	--



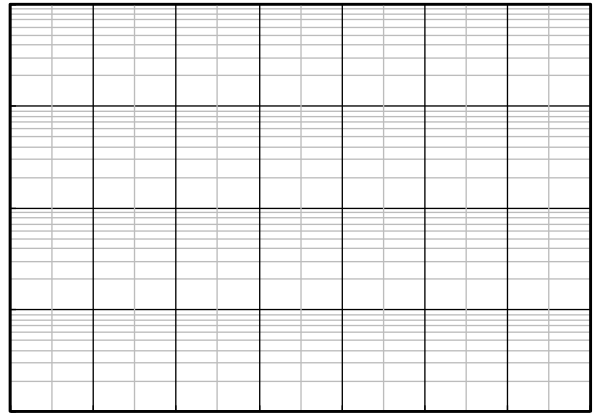
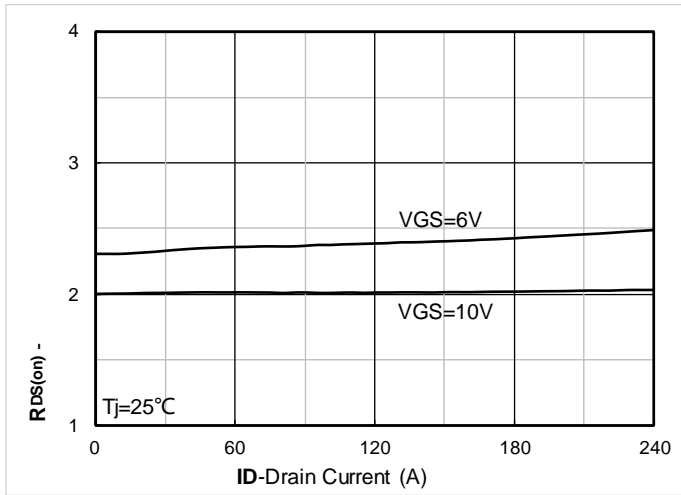

Figure 7.  $R_{DS(on)}$

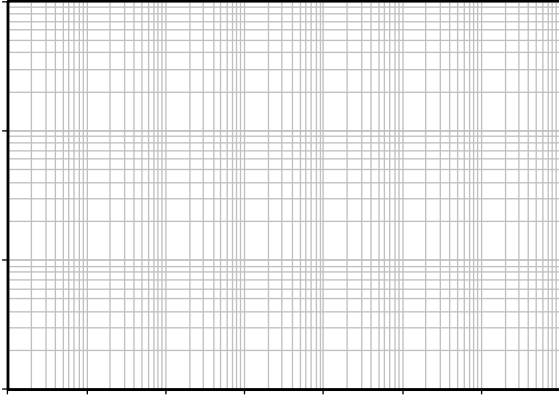

Figure 13. Maximum Transient Thermal Impedance

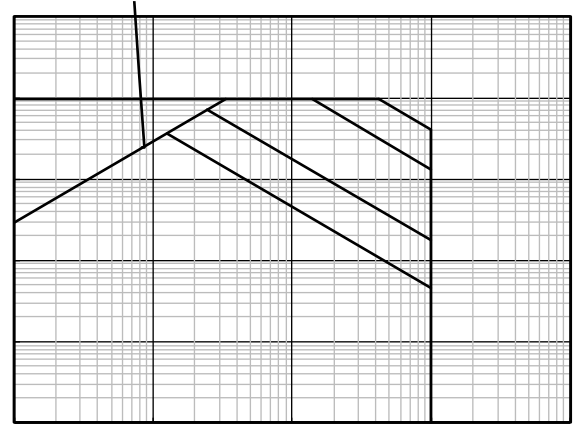

Figure 14m Transient Thermal

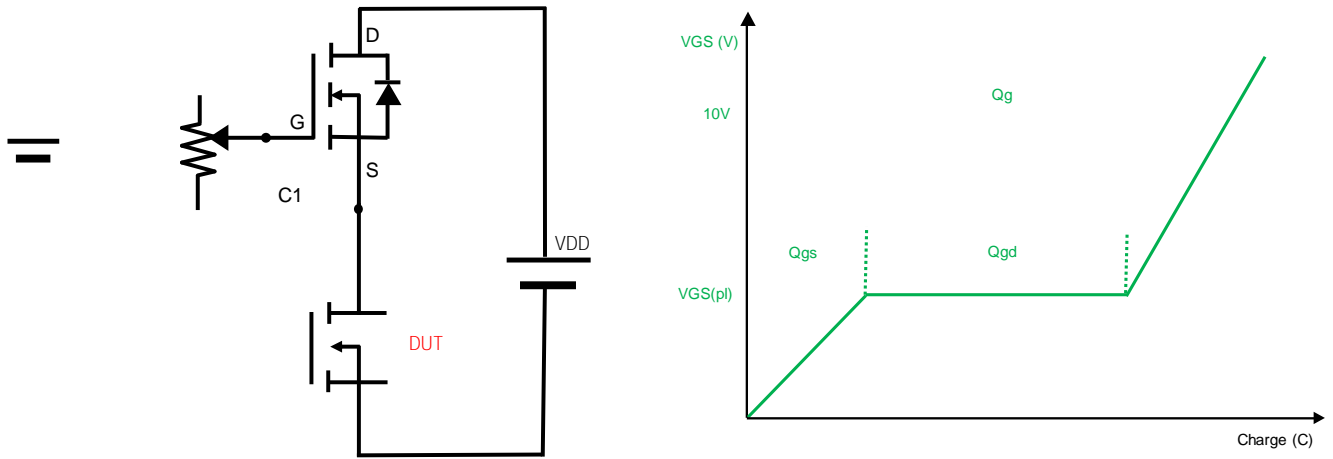

Figure B. Gate Charge Test Circuit & Waveform

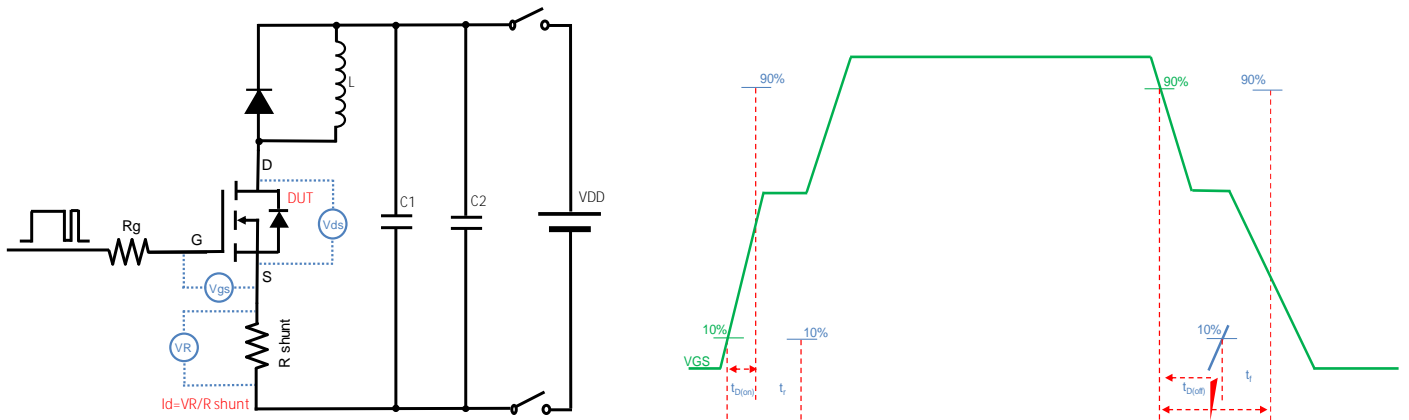

Figure C. Resistive Switching Test Circuit & Waveform

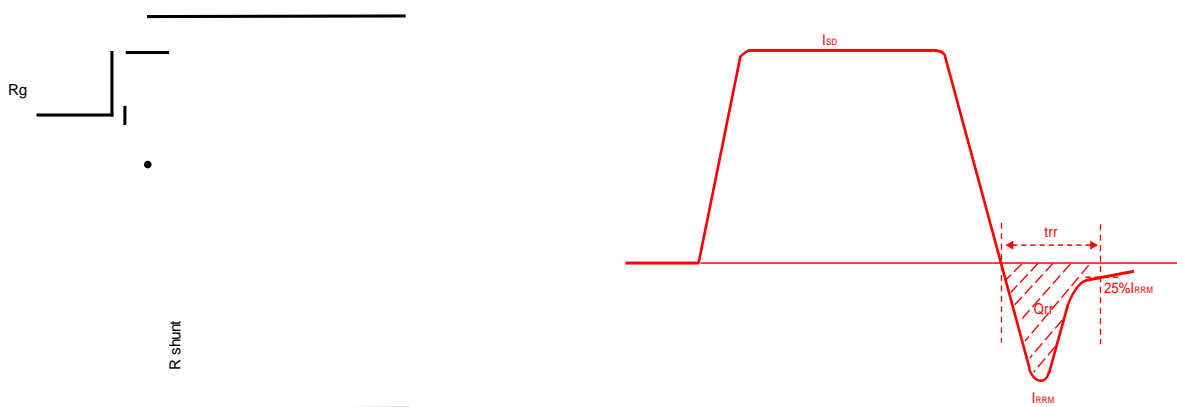
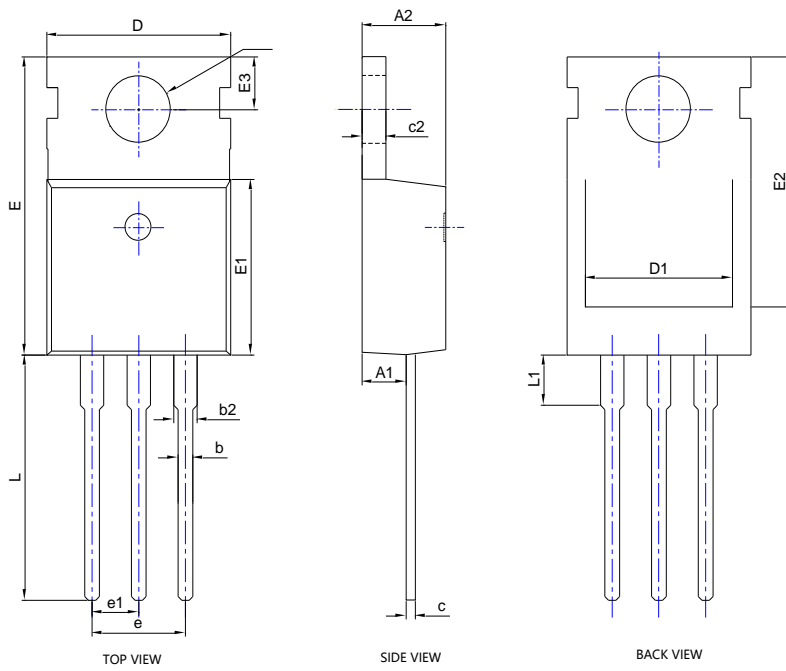

Figure D. Diode Recovery Test Circuit & Waveform



# YJP240G10H

## TO-220AB-E Package information



SYMBOL	DIMENSIONS			
	INCHES		Millimeter	
	MIN.	MAX.	MIN.	MAX.
A1	0.093	0.114	2.350	2.900
A2	0.176	0.184	4.470	4.670
b	0.028	0.036	0.710	0.910
b2	0.048	0.054	1.220	1.360
c	0.019	0.024	0.470	0.600
c2	0.047	0.055	1.200	1.400
D	0.382	0.408	9.700	10.370
D1	0.276	0.350	7.000	8.890
E	0.579	0.622	14.700	15.800
E1	0.350	0.373	8.900	

NOTE:  
1.PACKAGE BODY SIZES EXCLUDE MOLD FLASH AND GATE BURRS.  
2.TOLERANCE 0.1mm UNLESS OTHERWISE SPECIFIED.



## YJP240G10H

---

### Disclaimer

The information presented in this document is for reference only. Yangzhou Yangjie Electronic Technology Co., Ltd. reserves the right to make changes without notice for the specification of the products displayed herein to improve reliability, function or design or otherwise.

The product listed herein is designed to be used with ordinary electronic equipment or devices, and not designed to be used with equipment or devices which require high level of reliability and the malfunction of which would directly endanger human life (such as medical instruments, transportation equipment, aerospace machinery, nuclear-reactor controllers, fuel controllers and other safety devices), Yangjie or anyone on its behalf, assumes no responsibility or liability for any damages resulting from such improper use of sale.

This publication supersedes & replaces all information previously supplied. For additional information, please visit our website <http://www.21yangjie.com>