



YJJD05N03A

N-Channel Enhancement Mode Field Effect Transistor

Product Summary

V_{DS}	30V
I_D	5.0A
$r_{DS(ON)}$ (at $V_{GS}=10V$)	33mohm
$r_{DS(ON)}$ (at $V_{GS}=4.5V$)	55mohm
V_{DS} Tested	

General Description

Trench Power MV MOSFET technology
High Power and current handing capability

Applications

PWM application
S, a, @

Absolute Maximum Ratings ($T_A=25$ unless otherwise noted)

Parameter	Symbol	Limit	Unit
-----------	--------	-------	------



YJJD05N03A

Electrical Characteristics ($T_J=25$ unless otherwise noted)

Parameter	Symbol	Conditions	Min	Typ	Max	Units
Static Parameter						
Drain-Source Breakdown Voltage	BV_{DSS}	$V_{GS}=0V, I_D=250 \mu A$	30			V
Zero Gate Voltage Drain Current	I_{DSS}	$V_{DS}=30V, V_{GS}=0V$			1	μA
Gate-Body Leakage Current	I_{GSS1}	$V_{GS}= \pm 20V, V_{DS}=0V$			100	nA
Gate Threshold Voltage	$V_{GS(th)}$	$V_{DS}= V_{GS}, I_D=250 \mu A$	1.0	1.5	2.2	V
Static Drain-Source On-Resistance	$R_{DS(on)}$	$V_{GS}=10V, I_D=3.6$				

Typical Performance Characteristics

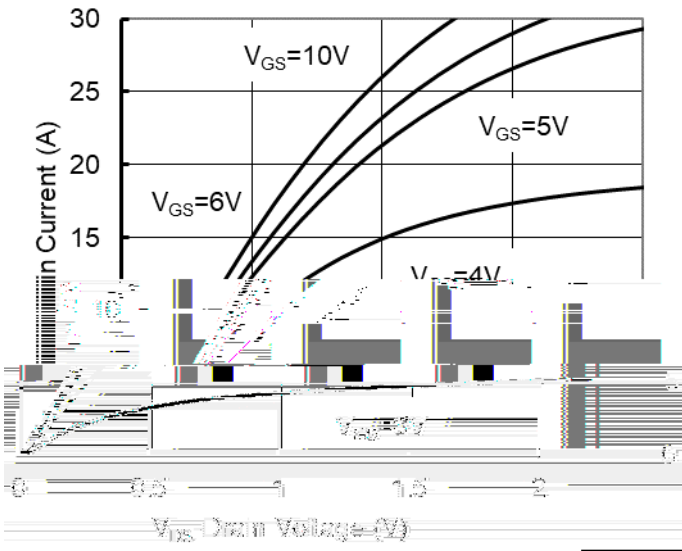

Figure1. Output Characteristics

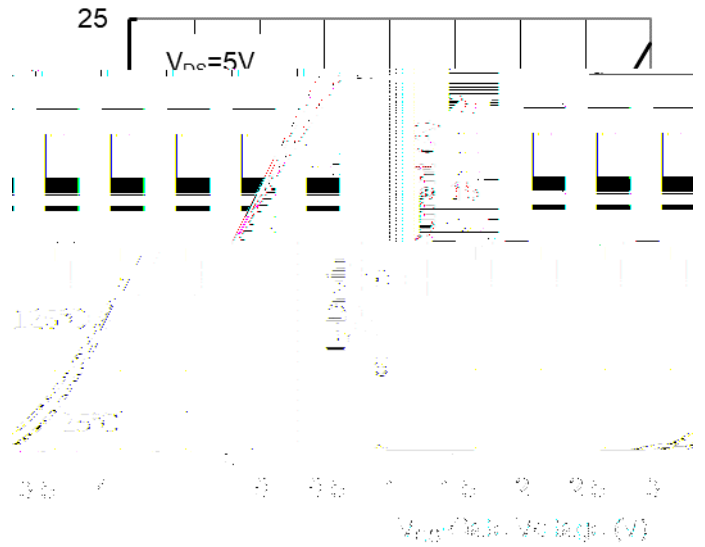

Figure2. Transfer Characteristics

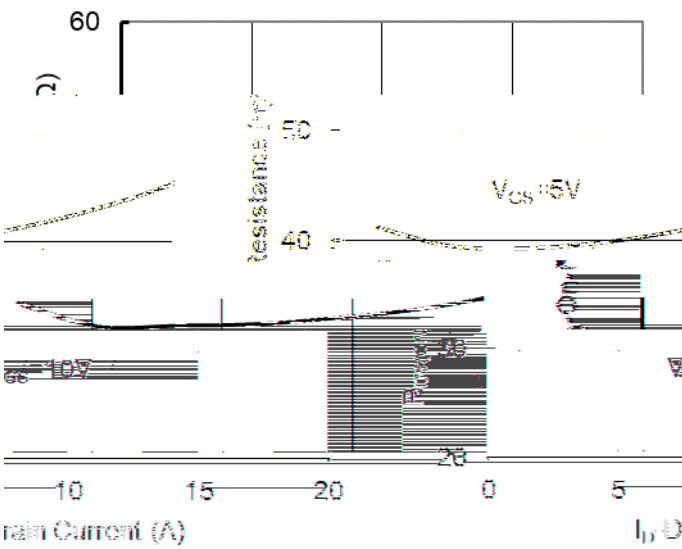

Figure 3: On-Resistance vs. Drain Current and Gate Voltage

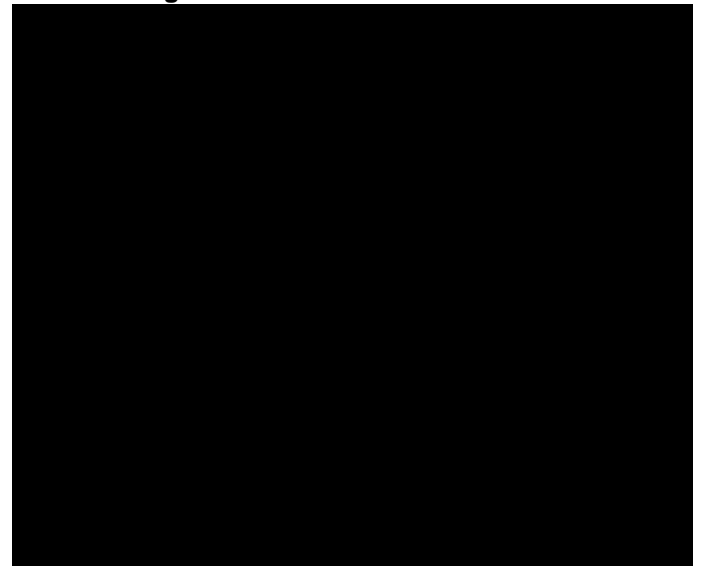

Figure 4: On-Resistance vs. Junction Temperature

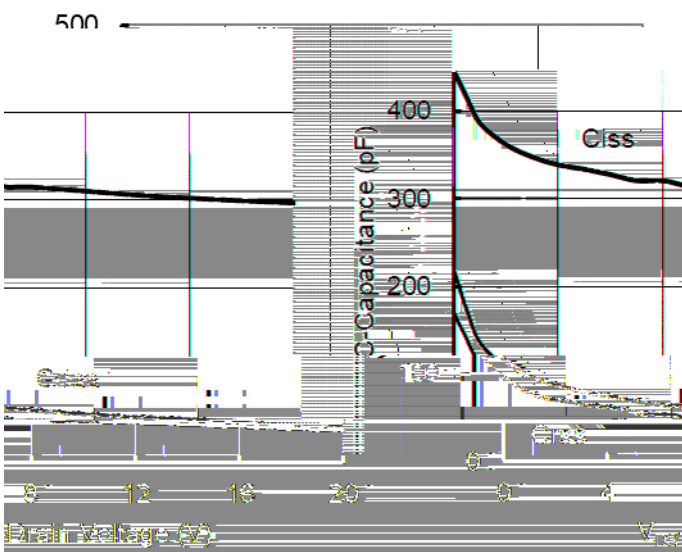

Figure5. Capacitance Characteristics

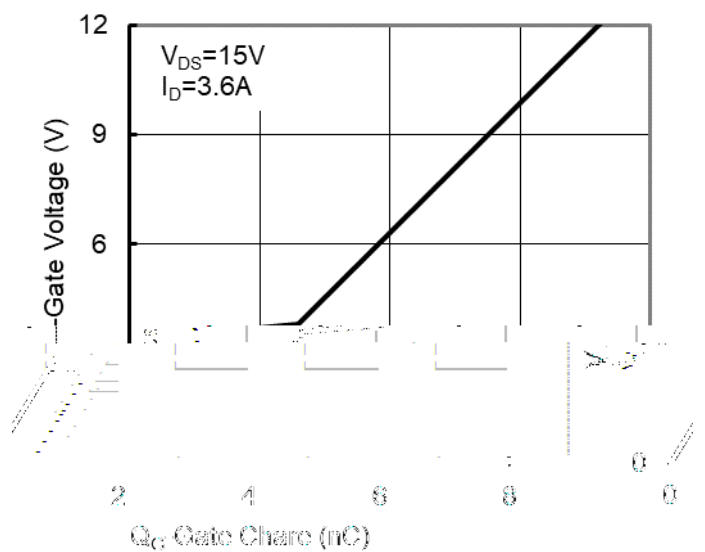

Figure6. Gate Charge

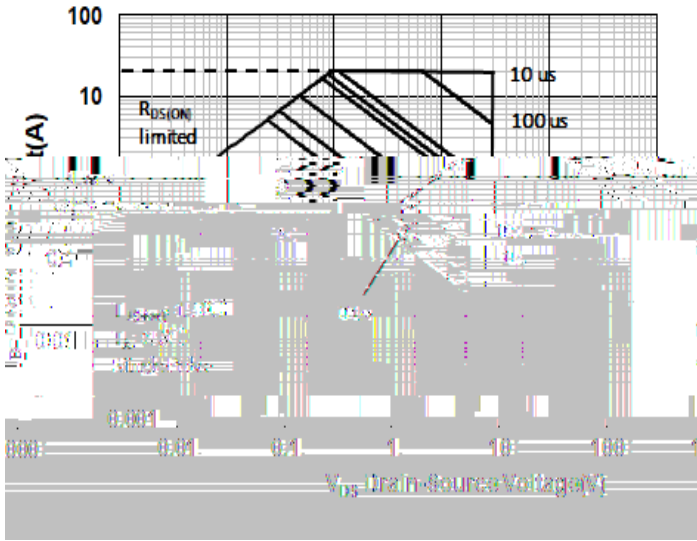

Figure7. Safe Operation Area

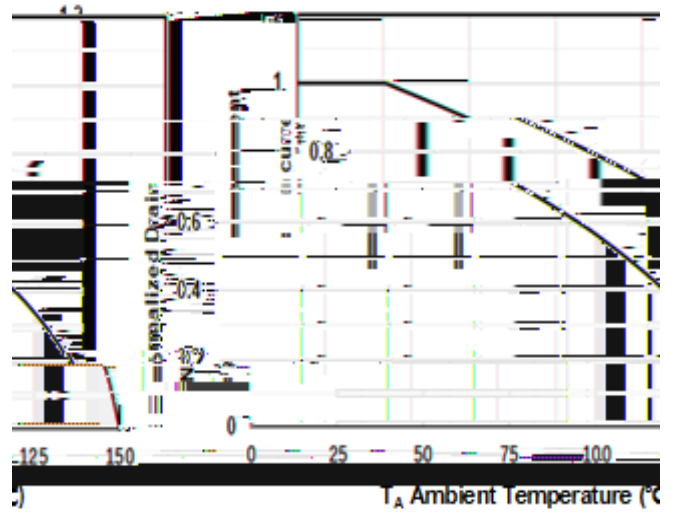

Figure8. Maximum Continuous Drain Current vs Ambient Temperature

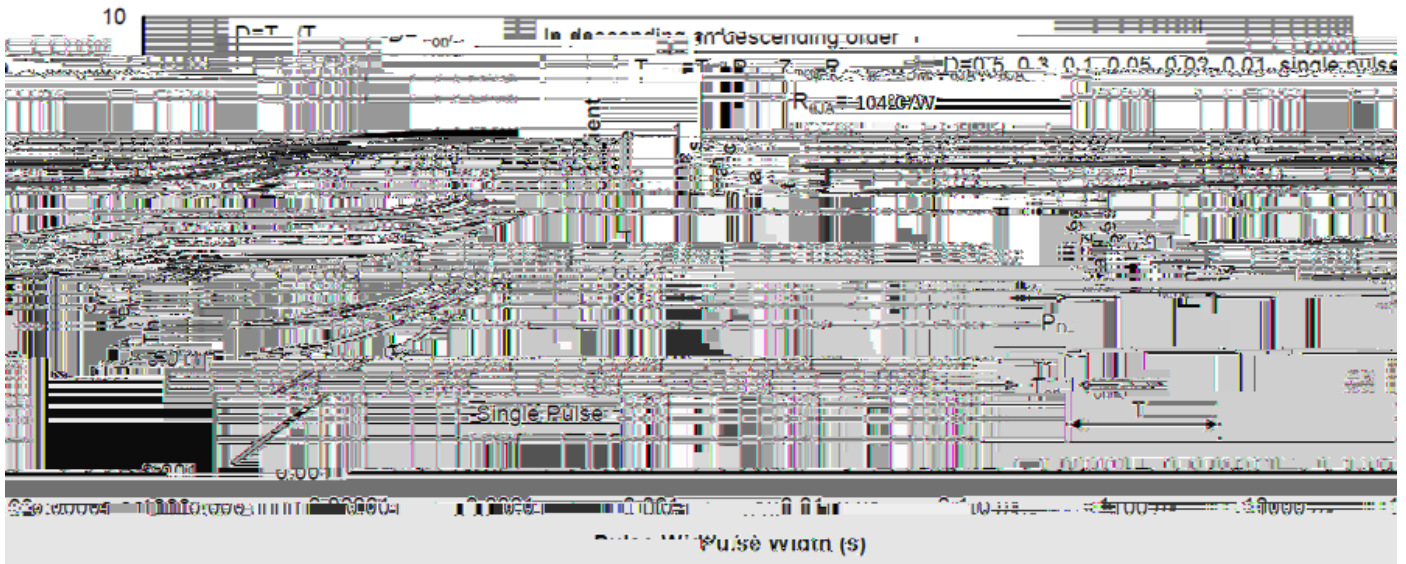
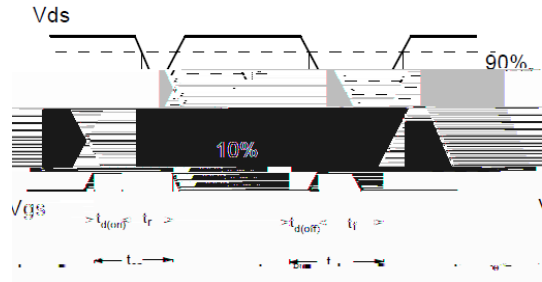
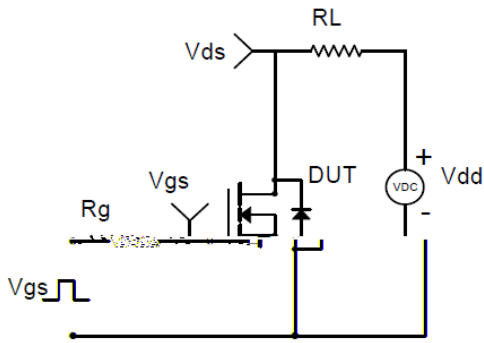
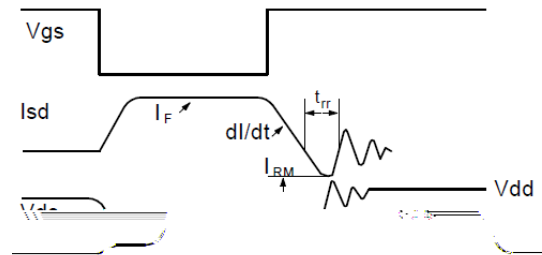
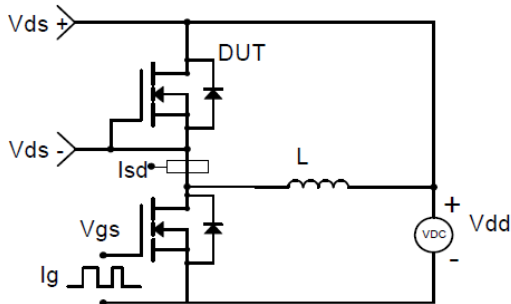

Figure9. Normalized Maximum Transient Thermal Impedance



Resistive Switching Test Circuit & Waveforms



Diode Recovery Test Circuit & Waveforms

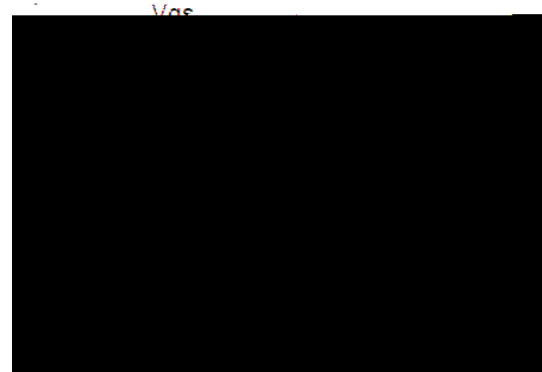

Gate Charge Test Circuit & Waveform

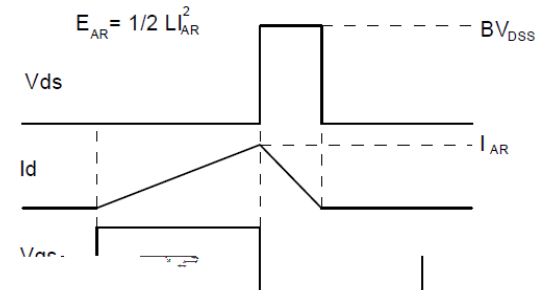
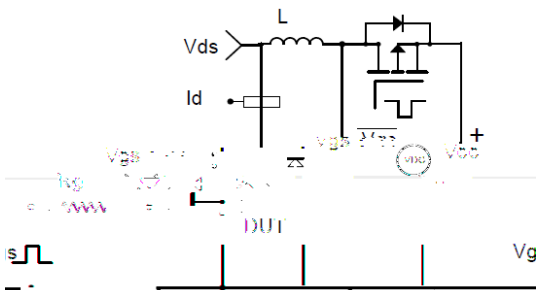

Unclamped Inductive Switching (UIS) Test Circuit & Waveforms



YJJD05N03A

SOT-23-6L Package information

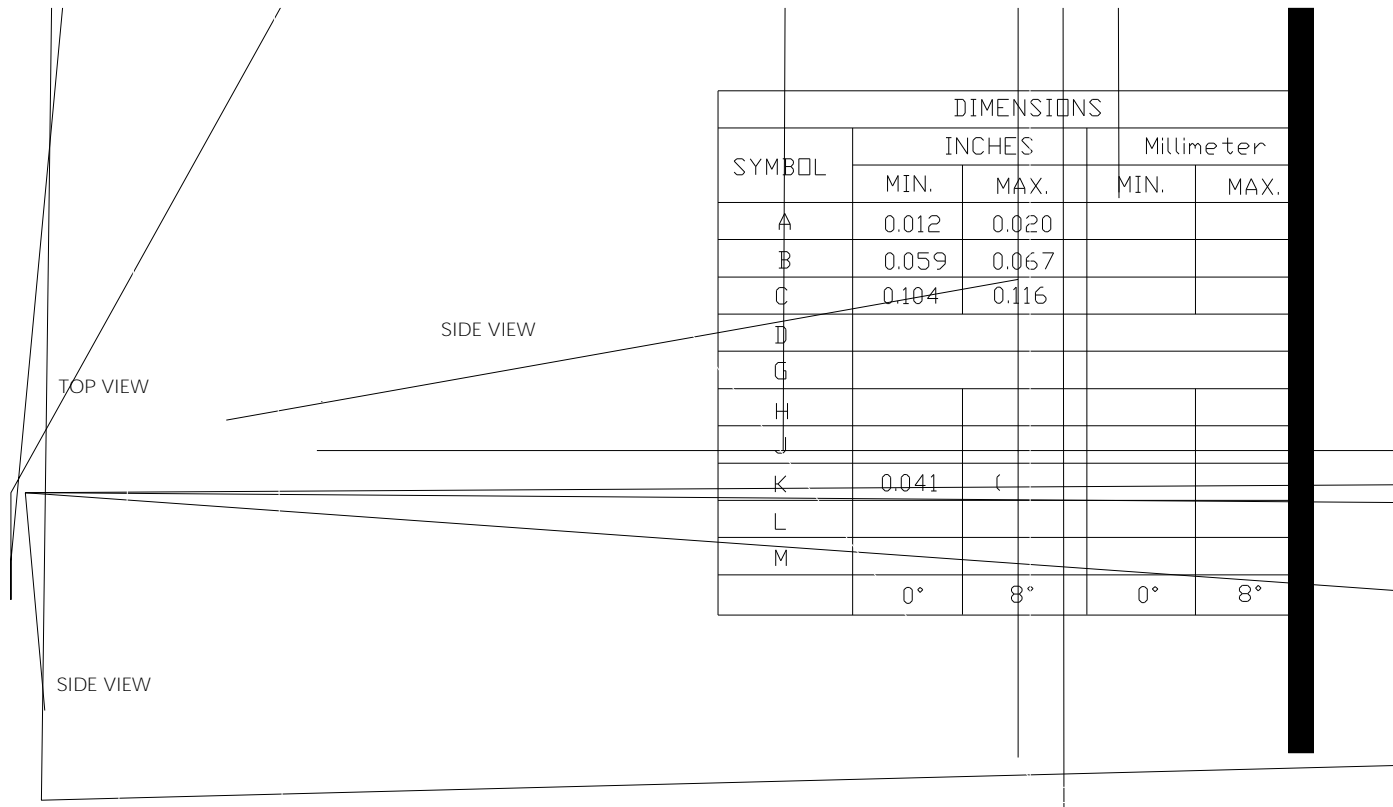



Disclaimer

The information presented in this document is for reference only. Yangzhou Yangjie Electronic Technology Co., Ltd. reserves the right to make changes without notice for the specification of the products displayed herein to improve reliability, function or design or otherwise.

The product listed herein is designed to be used with ordinary electronic equipment or devices, and not designed to be used with equipment or devices which require high level of reliability and the malfunction of with would directly endanger human life (such as medical instruments, transportation equipment, aerospace machinery, nuclear-reactor controllers, fuel controllers and other safety devices), Yangjie or anyone on its behalf, assumes no responsibility or liability for any damages resulting from such improper use of sale.

This publication supersedes & replaces all information previously supplied. For additional information, please visit our website [http:// www.21yangjie.com](http://www.21yangjie.com)