



YJG110G08HR

N-Channel Enhancement Mode Field Effect Transistor

Product Summary

V_{DS}	80V
I_D	110A
$R_{DS(ON)}$ (at $V_{GS}=10V$)	3.9m
$R_{DS(ON)}$ (at $V_{GS}=6V$)	6m
100% EAS Tested	
100% V_{DS} Tested	

General Description

Split gate trench MOSFET technology
Excellent package for heat dissipation
High density cell design for low $R_{DS(ON)}$
Moisture Sensitivity Level 3
Epoxy Meets UL 94 V-0 Flammability Rating
Halogen Free

Applications

Power switching application
Uninterruptible power supply
DC-DC convertor

Absolute Maximum Ratings ($T_A=25$ unless otherwise noted)

Parameter	Symbol	Limit	Unit
Drain-source Voltage	V_{DS}	80	V
Gate-source Voltage	V_{GS}	± 20	V

$T_A=25$

Drain Current

I_D



YJG110G08HR

Electrical Characteristics ($T_J=25$ unless otherwise noted)

Parameter	Symbol	Conditions	Min	Typ	Max	Units
Static Parameter						
Drain-Source Breakdown Voltage	BV_{DSS}	$V_{GS}=0V, I_D=250\mu A$	80	-	-	V



YJG110G08HR

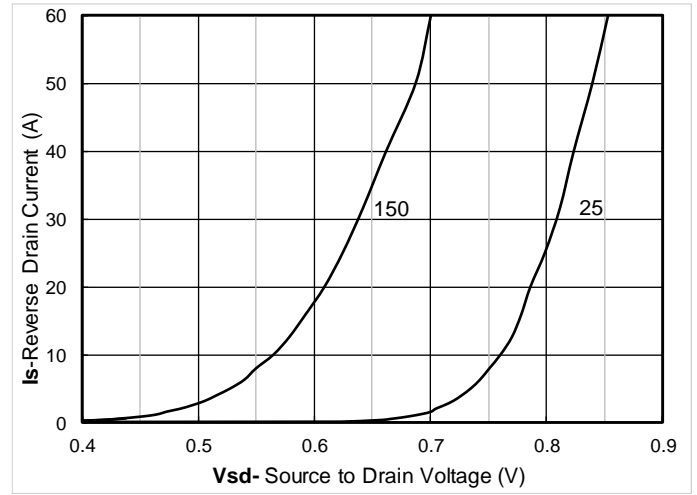
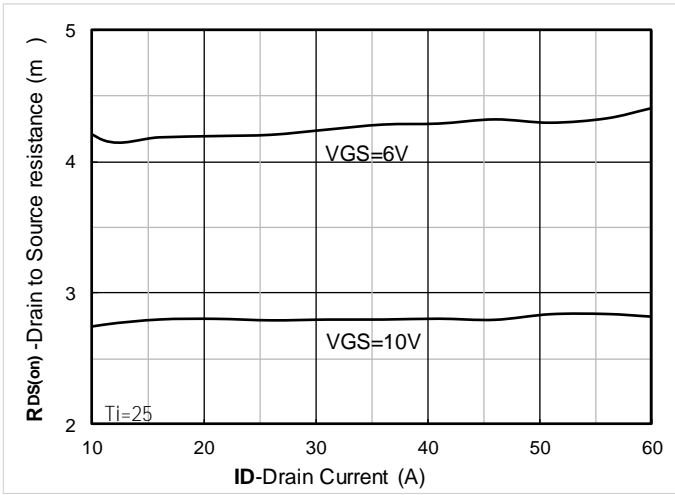

Figure 7. $R_{DS(on)}$

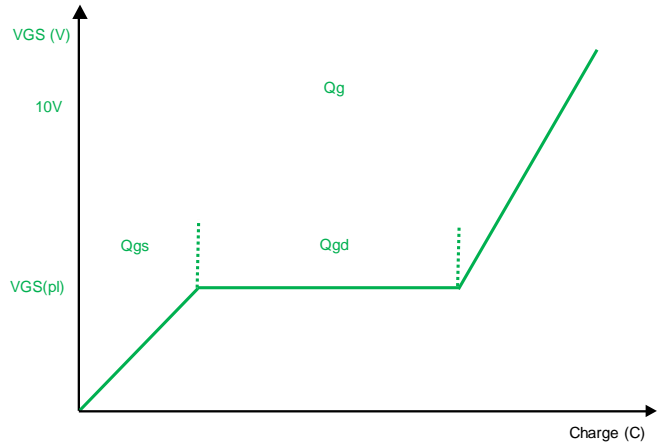
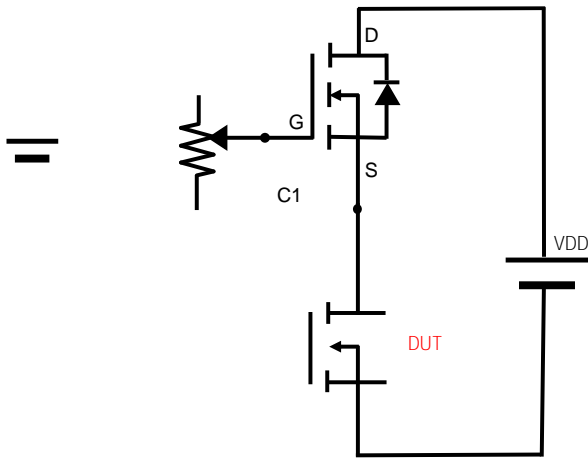

Figure B. Gate Charge Test Circuit & Waveform

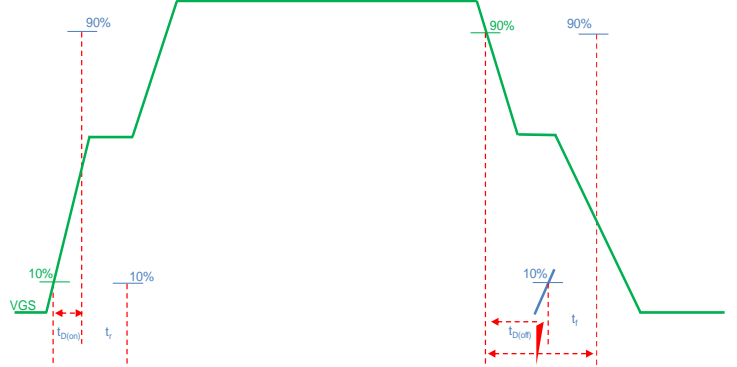

Figure C. Resistive Switching Test Circuit & Waveform

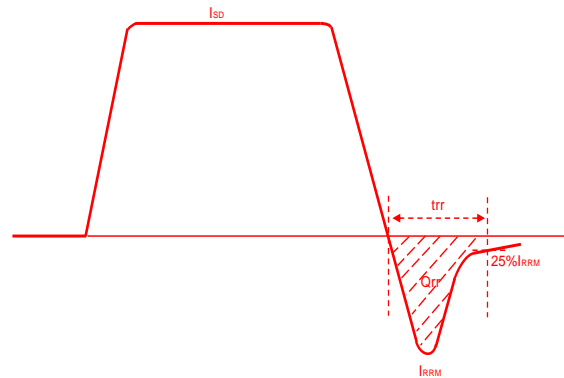
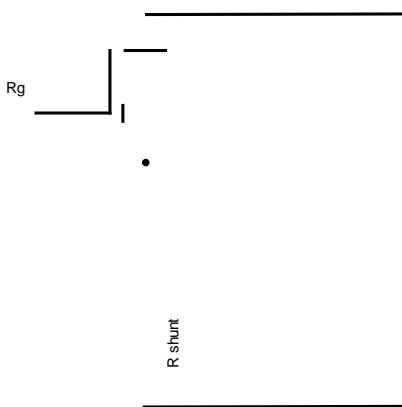

Figure D. Diode Recovery Test Circuit & Waveform

YJG110G08HR



YJG110G08HR

Disclaimer

The information presented in this document is for reference only. Yangzhou Yangjie Electronic Technology Co., Ltd. reserves the right to make changes without notice for the specification of the products displayed herein to improve reliability, function or design or otherwise.

The product listed herein is designed to be used with ordinary electronic equipment or devices, and not designed to be used with equipment or devices which require high level of reliability and the malfunction of which would directly endanger human life (such as medical instruments, transportation equipment, aerospace machinery, nuclear-reactor controllers, fuel controllers and other safety devices), Yangjie or anyone on its behalf, assumes no responsibility or liability for any damages resulting from such improper use of sale.

This publication supersedes & replaces all information previously supplied. For additional information, please visit our website <http://www.21yangjie.com> , or consult your nearest Yangjie's sales office for further assistance.