

; YbYfU` 8YgWf]dh]cb`

5dd`]WUh]cbg`

		±	

			mJ
			/

CfXYf]b [ `=bZcf a Uh]cb`

DF9:9F98'D#B`	D57?:B ;` 7C89`	AUf_]b [ `	A=B-A I A` D57 ? 5 ; 9fidWgk	-BB9F`6CL` E I 5BH=HMfidWgk	C I H9F`75FHCB` E I 5BH=HMfidWgk	89@=-J9FM`AC89





# M>8 '\$B\$&5

'Hmd]WU''DYfZcf a UbWY' 7 \UfUWhYf]gh]Wg'

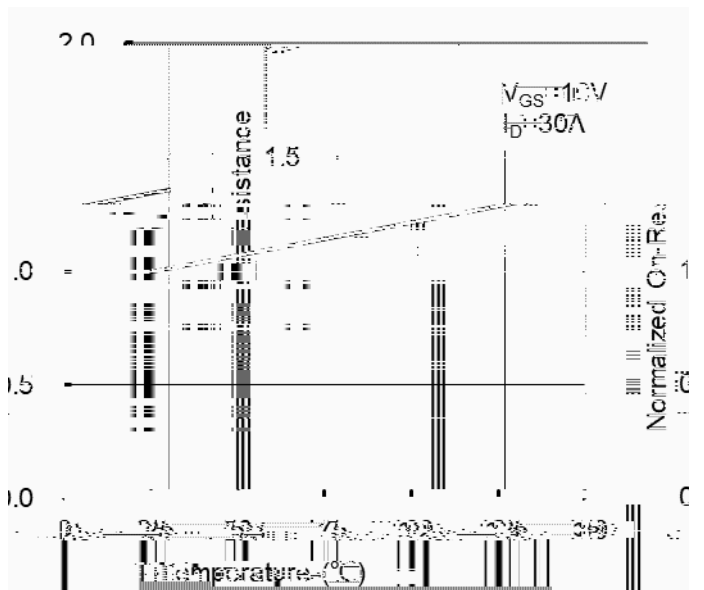
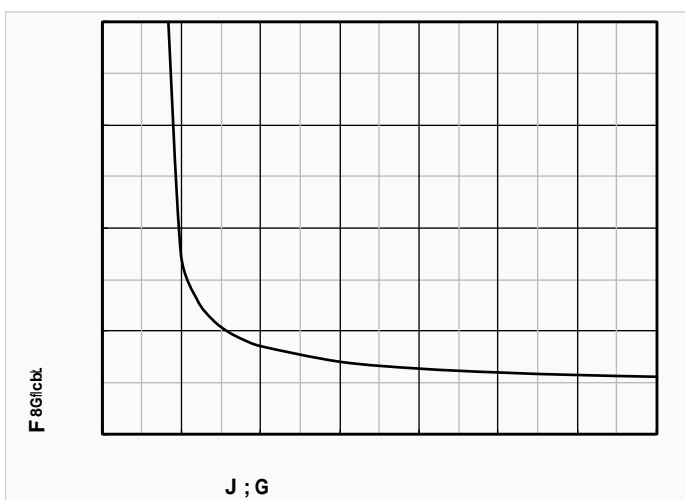
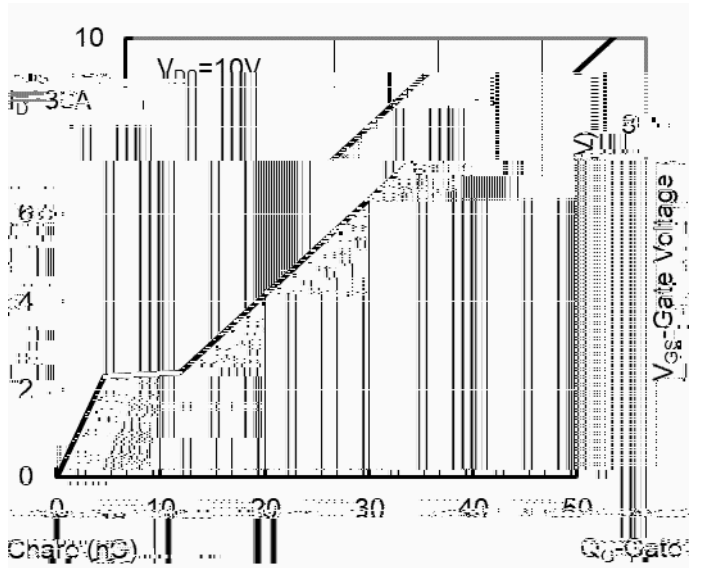
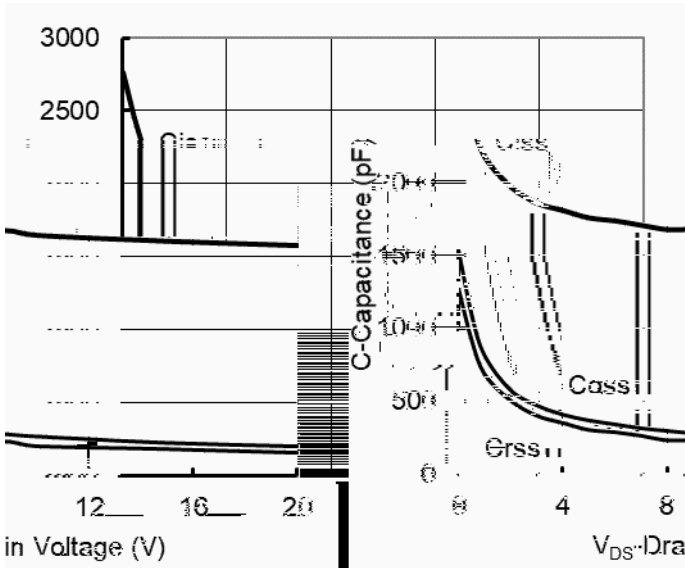
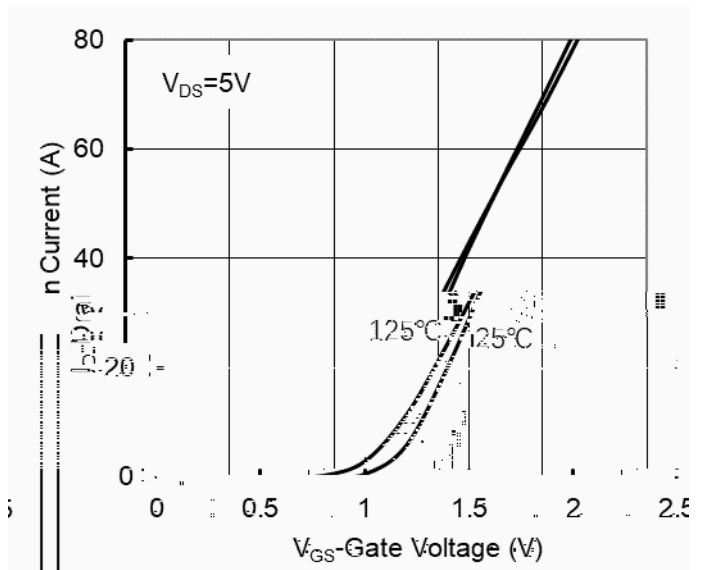
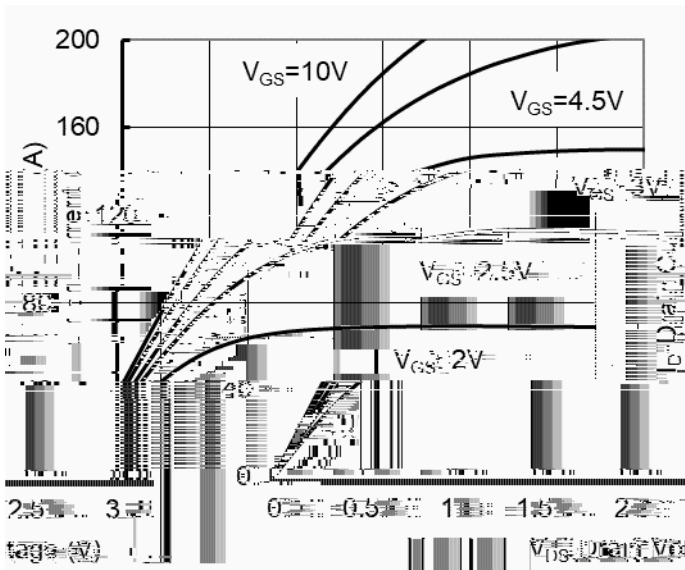



M>8 '\$B\$&5

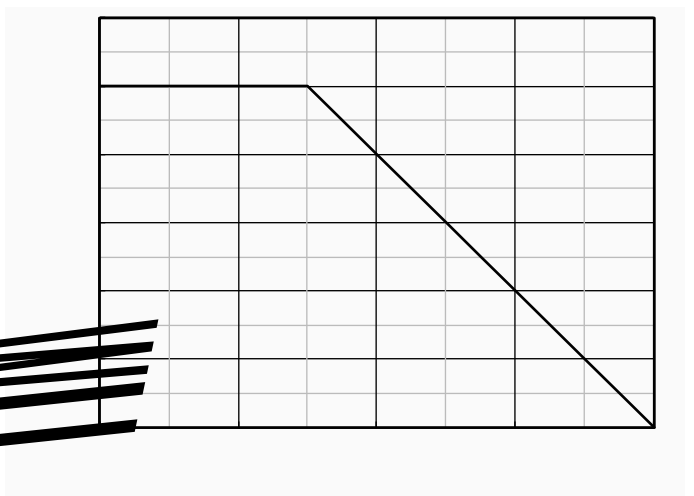
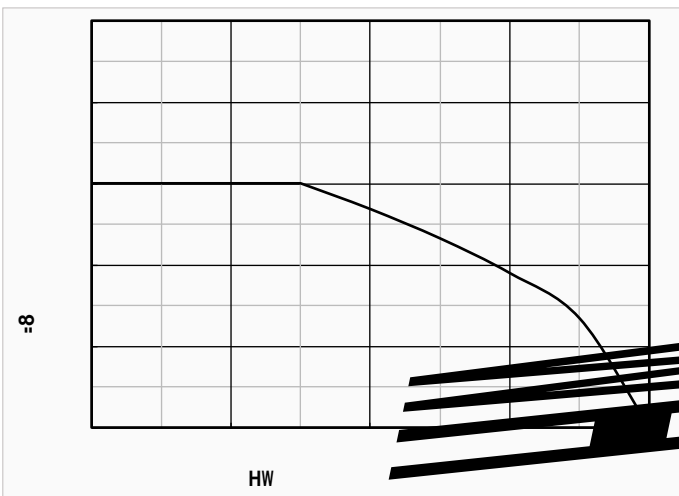
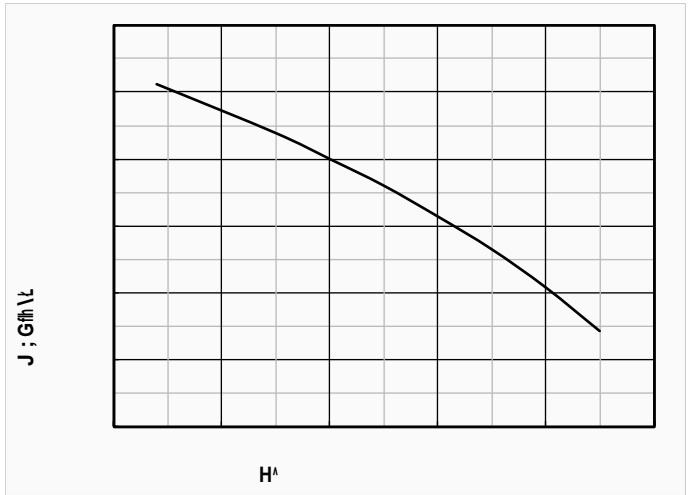
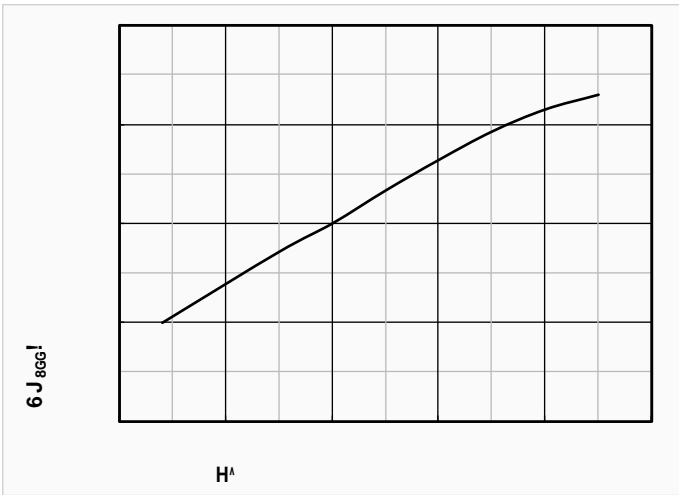
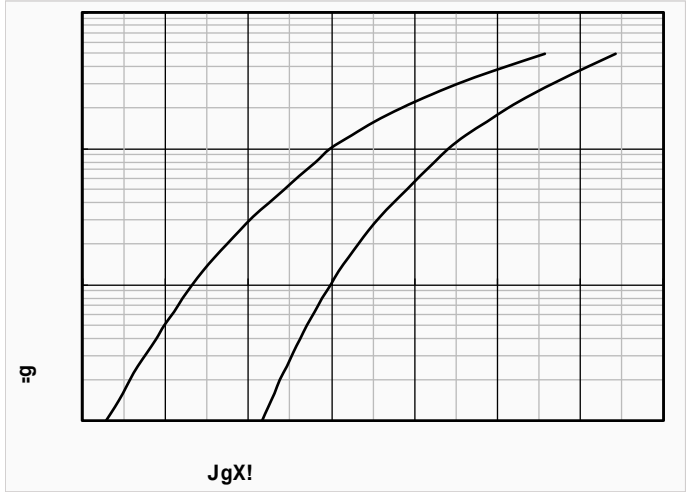
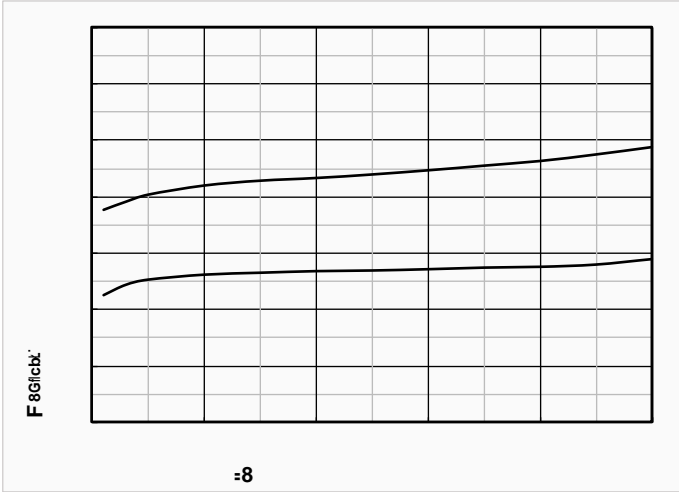



# M>8 '\$B\$&5

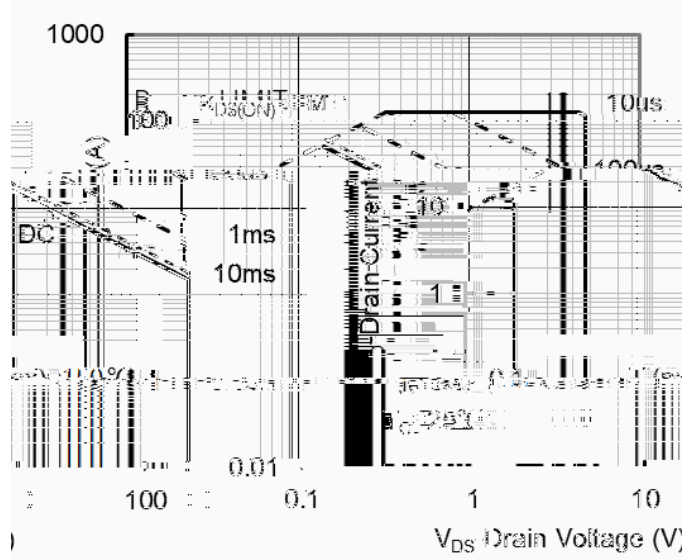
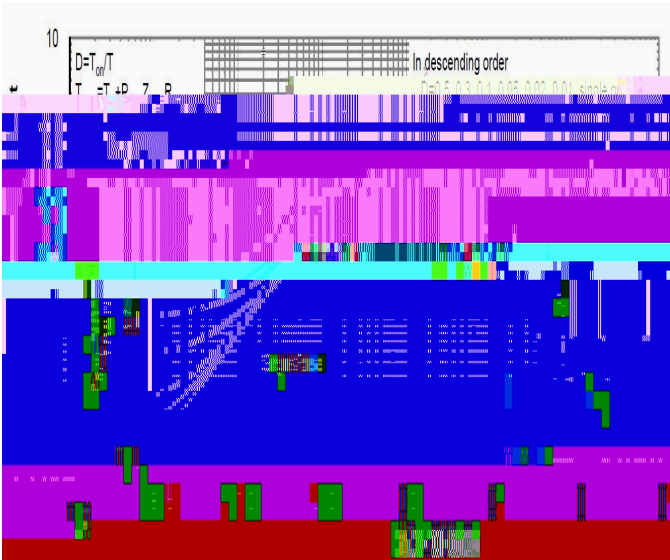

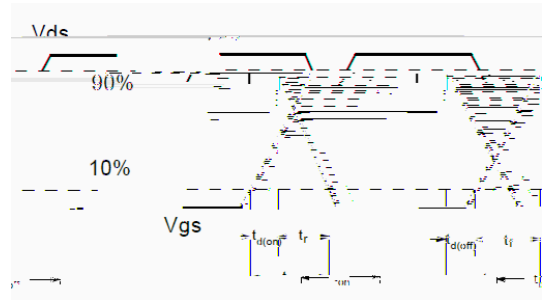
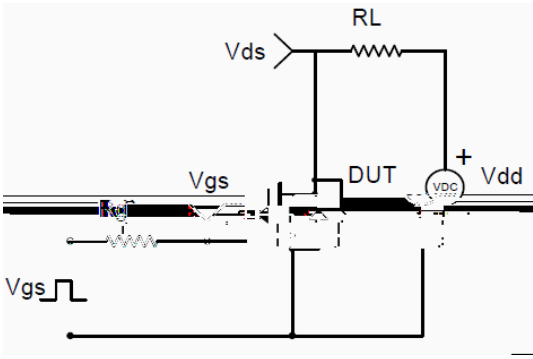

FYg]gh]jY'Gk]hW\]b[ 'HYgh'7]fWi]h' /' KUjYZcf ag'

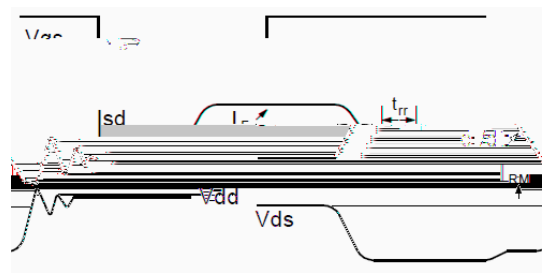
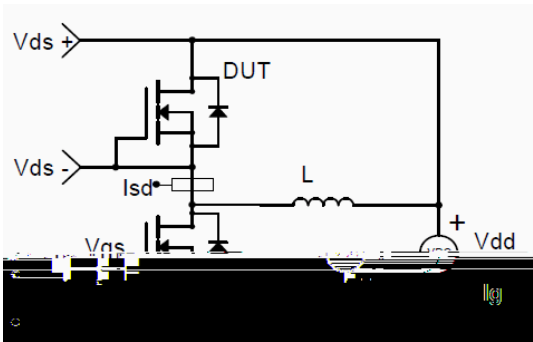

8]cXY'FYwc jYfm'HYgh'7]fWi]h' /' KUjYZcf ag'

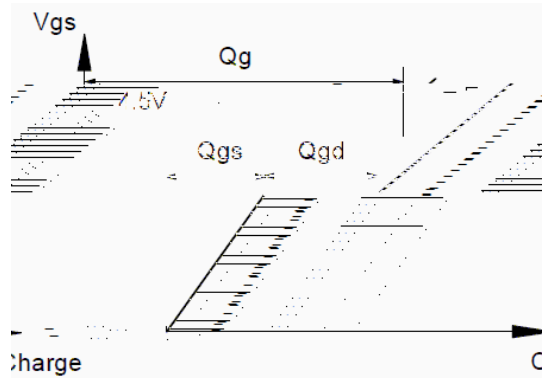
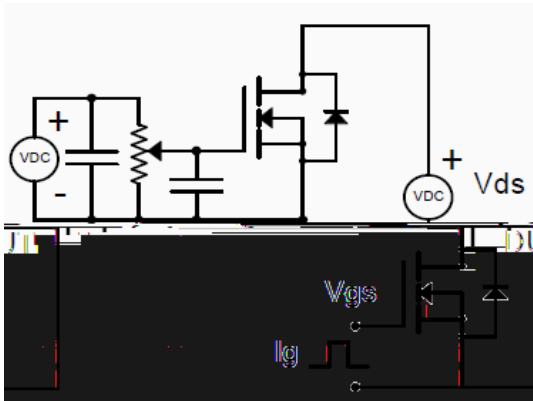

;UhY'7\Uf[Y'HYgh'7]fWi]h' /' KUjYZcf a'

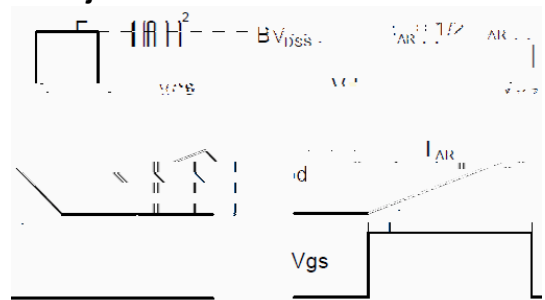
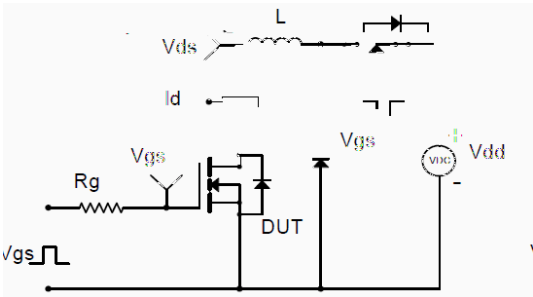

I bW'U a dYX' =bXi Wh]jY'Gk]hW\]b[ 'fI =GL'HYgh'7]fWi]h' /' KUjYZcf ag'

:



M>8 '\$B\$&5

HC!&)&!6''DUW\_U[Y']bZcf a Uh]cb'

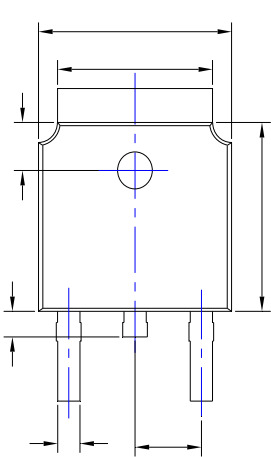

TOP VIEW

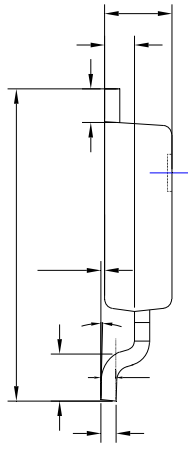

SIDE VIEW

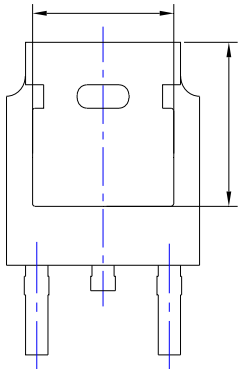
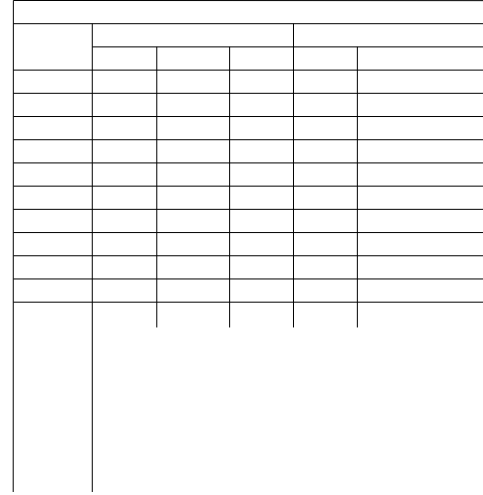

BOTTOM VIEW

SUGGESTED SOLDER PAD LAYOUT

**M>8 '\$B\$&5**

---