

/LQH 8QL GLUHFWRQRQ 7UDQVLHQW 9RO

)HDWXUHV
 " 6WDQG RII YROWDJH 9 0D[
 " 7UDQVLHQW SURWHFWLRQ IRU HDFK O
 ,(& (6' " N9 FRQWDFW
 ,(& VXUJH \$ V
 " /RZ OHDNDJH FXUUHQW
 " 8OWUD ORZ FODPSLQJ YROWDJH
 " 5R+6 &RPSOLDQW

\$\$SOLFDFWRQV
 " &HOOXODU +DQGVHWV DQG \$FFHVVRUL
 " 3HUVRQDO 'LJLWDO \$VVLVWDQWV
 " 1RWHRRNV DQG +DQGHOGV
 " 3RUWDEOH ,QVWUXPHQWDFWRQ
 " 'LJLWDO &DPHUDV
 " 3HULSKHUDOV
 " \$XGLR 3OD\HUV

0HFKDQLFDO 'DWD
 " 3DFNDJH 62'
 " /HDG)LQLVK 0DWWH 7LQ
 " &DVH 0DWHULDO 3*UHHQ' 0ROGLQJ &R
 " 0RLVWXUH 6HQVLWLYLW\ /HYHO SHU
 " 0DUNLQJ WQLRQPHH %HORZ

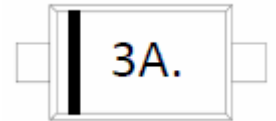
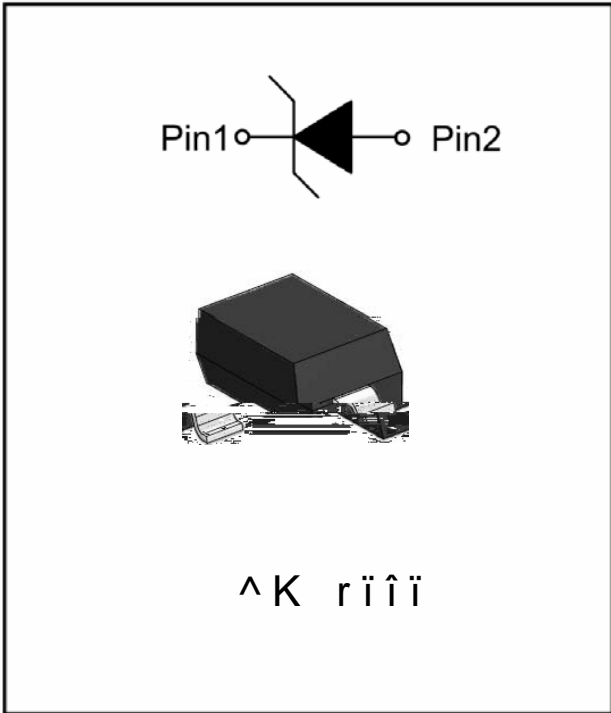

V'HILQLWLRQV RI HOHFWULFDO FKDUDFWHULVWLFV

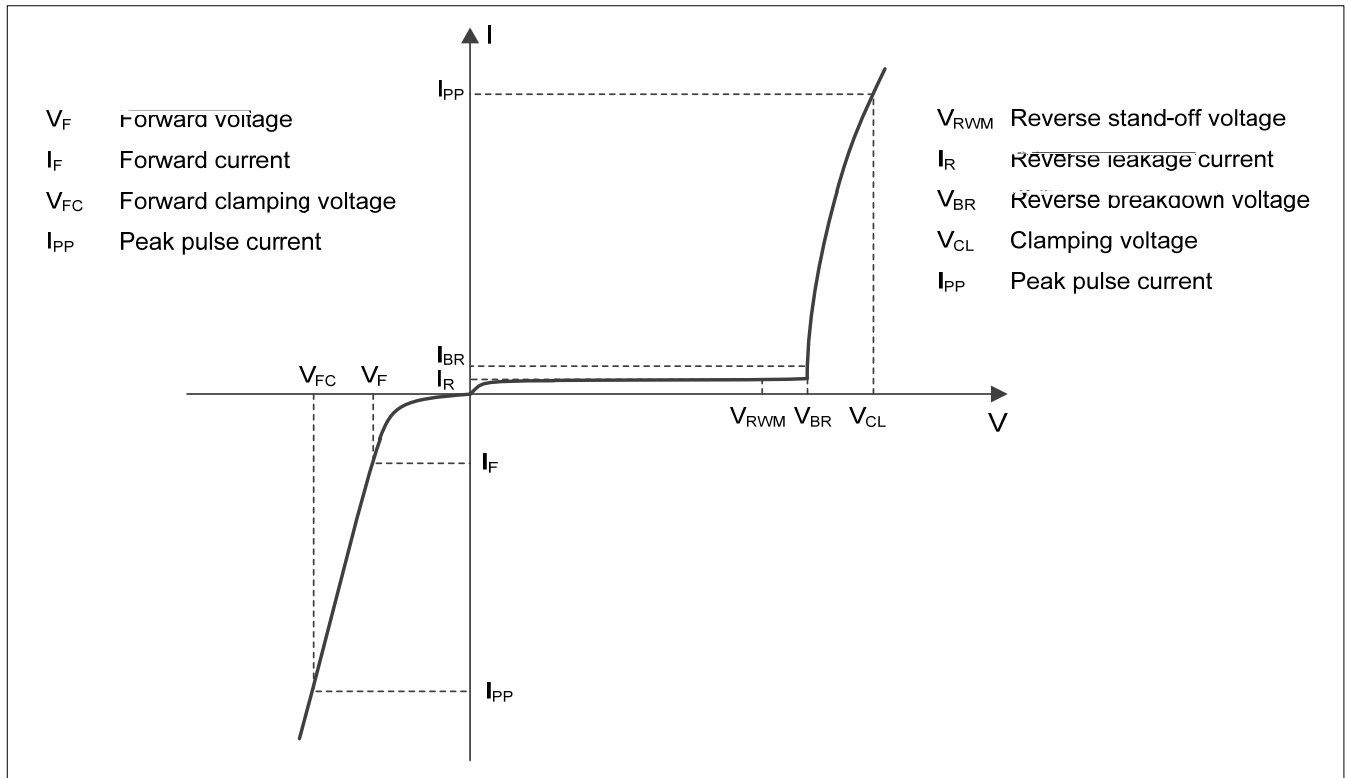



(6 ' 9 ' \$

V0D[LPXP 5DWLQJV

3\$5\$0(7(5	6<0%2/	/,0,76	81,7
3HDN SXOVH SRZHV W	3SN		:
3HDN SXOVHsFXUUHQW W	,33		
(6' DFFRUGLQJ WR ,(& DLU GLVF	KDUJH	"	.9
(6' DFFRUGLQJ WR ,(& FRQWDFW	9(6' GLVFKDUJH	"	
-XQFWLRQ WHPSHUDWXUH	-	ā	R&
6WRUDJH WHPSHUDWXUH	67*	7a	R&

v(OHFWULFDO &KDUDFWHULVWLFV



(6 ' 9 ' \$

3 HDN SXOVH FXUUHQW

v & KDUDFWHULVWLFV 7 \ SLFDO

) LJ V ZDYFISHRW , (&

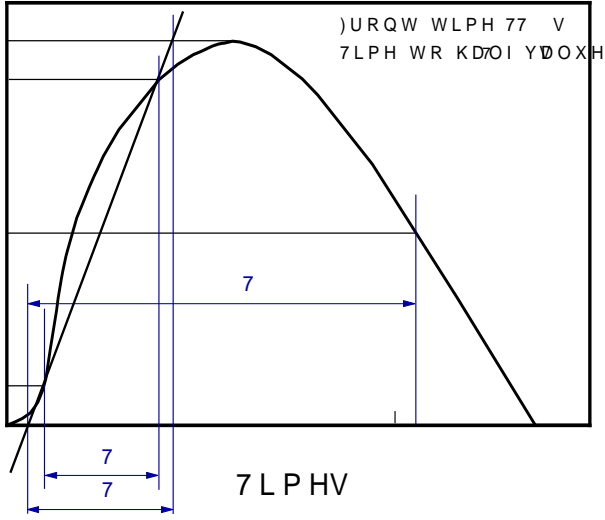



(6 ' 9 ' \$

v 2XWOLQH 'LPHQVLRQV

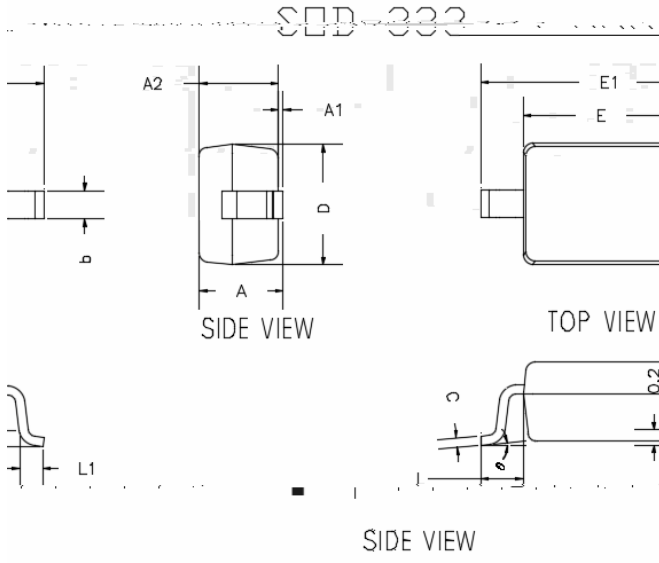

DIMENSIONS				
DIM	INCHES		MM	
	MIN	MAX	MIN	MAX
A	---	0.0393	---	1.0000
0.0000	0.0039	0.0000	0.1000	A1
0.0314	0.0354	0.8000	0.9000	A2
0.0098	0.0157	0.2500	0.4000	b

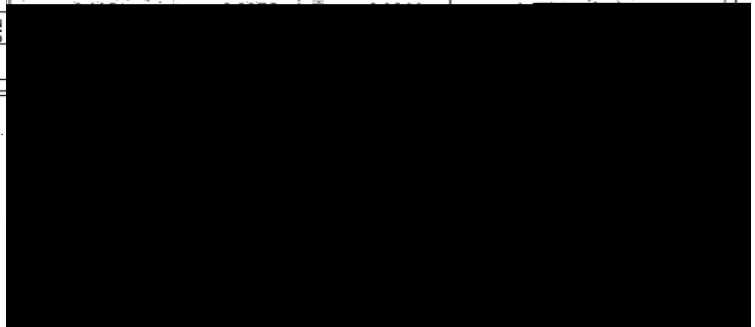

v 6ROGHULQJ)RRWSULQW

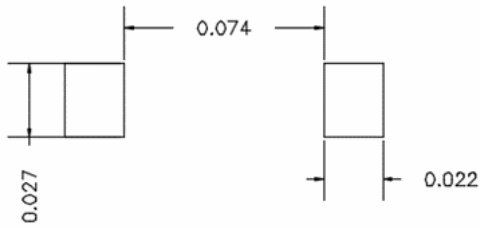

UNIT: inch

SUGGESTED BOARD LAYOUT



(6 ' 9 ' \$

'LVFODLPHU

7KH LQIRUPDWLRQ SGRVH DMQHG LQ IRKLVH DIIHJH RKH BQJMLH (OHFWURQLF 7HFHQRO
ULJKW WR PDNH FKDLFH VRZLWKR XWS KRLS LURDG XIERQ/ RGLWSOD\HG KHUHLQ WURGLPSLWRQ
RU RWKHUZLVH

7KH SURGXFW OLVWHG KHUHLQ LV GHVH H QW G RQR FE HTXVLS BHZLW KR UR LGHLYLDFHWVW DQG
HTXLSPHQW RU GHYLFHV ZKLFK UHTGLW KH K E D O OXHQFHVGRG LURH OZLWDL BQJMLH DQJMLH
PHGLFDO LQVWUXPHQW VIT WLSDFHGR U D H H V R V S O X F F O F D E K W D F W R L O F R Q D V L G R B O H H U V I
GHYLFHV <DQJMLH RU DQ\ RQH RQ LWV O E M K D R U O D V E X D H L W Q R R W H D G S R Q D E B J K V H U H V
RI VDOH

7KLV SXEOLFDWLRQ SVOISFHUW DGDV LQ URQV D X S R Q L S G H Y R U X D G G L W L R Q D O L Q W R H U P D W L R
K W W [VZ](#) \DQJMLH R R R P R Q V X O W \ R X U Q H D U H V W <DQJMLH V M D Q V D I O H V R I I L F H I R U I X U W